

Installation accessories
Stacking kit for 6 GN 1/1 oven
placed on electric 6 or 10 GN 1/1

ITEM # _____

MODEL # _____

NAME # _____

SIS # _____

AIA # _____

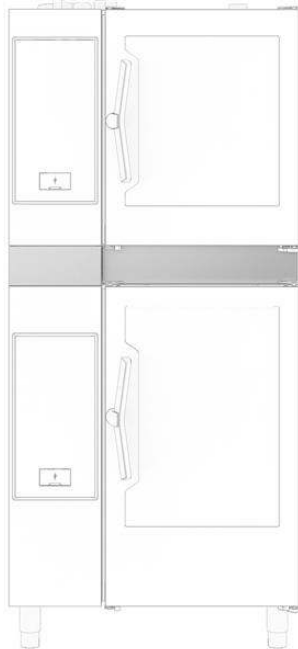

922620 (STK61161011)

Stacking kit for 6+6 GN 1/1
ovens on electric 6+10 GN 1/1
GN ovens

Main Features

- Ideal for saving kitchen space.
- Includes: supports, external panels, flue and water pipes, drain connection and adjustable feet.
- The kit can be mounted on site.
- Typology (gas, electric) must be ordered considering the oven that will be placed at the bottom.

Key Information:

External dimensions,
Width:

922620 (STK61161011) 867 mm

External dimensions,
Depth:

895 mm

External dimensions,
Height:

120 mm

Net weight:

50 kg

Shipping weight:

38 kg

APPROVAL: _____

Front

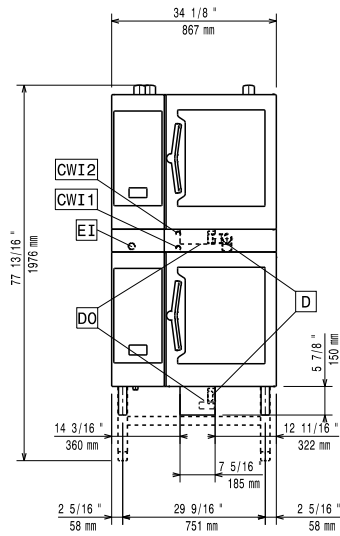

Side

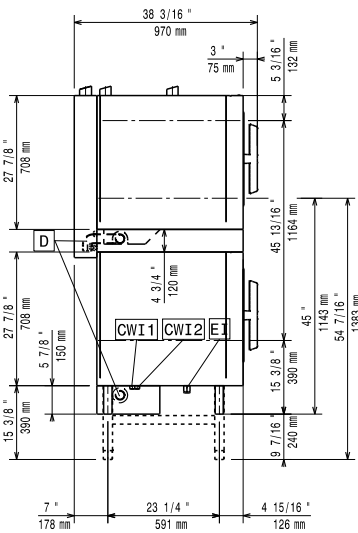

Top

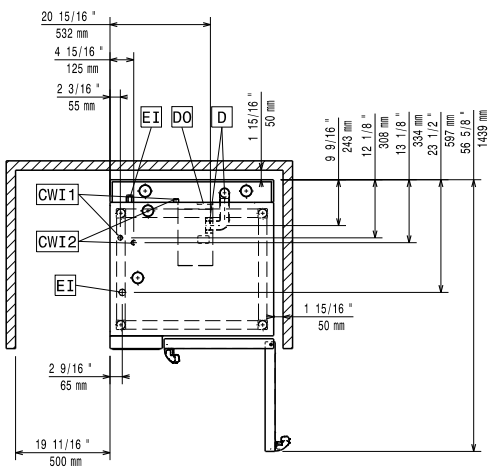

Front

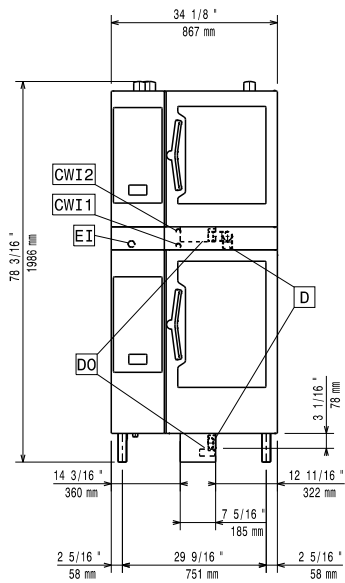

Side

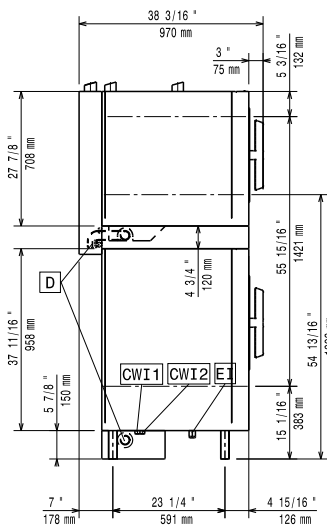

Top

